

⚠安全指示

- 1) 在安装或使用本产品前，使用者必须详细阅读本操作手册。
- 2) 本产品须由受过正确训练的人员来安装或操作。安装作业时必须关闭所有电源，切记不可带电操作。
- 3) 所有标有⚠符号的指示，必须特别注意并按照说明书上的执行，以免造成不必要的损害。
- 4) 为安全起见，禁止以延长线作电源座供应二项以上的电器产品使用。
- 5) 在连接电源线时，必须确定工作电压低于 AC 250V，且符合本产品标识中规定的额定电压值。
※注意：电控箱电源规格如为 AC220V 时，请勿插接至 AC380V 的电源插座上，否则将出现异常且电机无法动作。此时请立即关闭电源开关，重新检查电源。持续供应 380V 超过五分钟以上，将可能烧损电控箱内器件，而危及人身安全。
- 6) 请不要在日光直接照射的场所、室外及室温 45℃ 以上或 0℃ 以下的场所操作。
- 7) 请不要在暖气（电热器）旁、有露水的场所及在相对湿度 10% 以下或 90% 以上的场所操作。
- 8) 请不要在灰尘多的场所、具有腐蚀性物质的场所及有挥发性气体的场所操作。
- 9) 请注意所有电源线、信号线、接地线等接线时不要受压或过度扭曲，以确保使用安全。
- 10) 电源线的接地端须以适当大小的导线和接头连接到生产工厂的系统地线，此连接必须被永久固定。
- 11) 所有可转动的部分，必须以所提供的零件加以防范露出。
- 12) 在安装完成第一次开电后，先关闭切线功能以低速操作缝纫机并检查转动方向是否正确、运转是否稳定。
- 13) 在进行以下操作前，请先关闭所有电源：
 1. 在控制箱与马达上插拔任何连接插头时。
 2. 穿针线时。
 3. 翻抬缝纫机机头时。
 4. 修理或做任何机械上的调整时。
 5. 机器闲置不用时。
- 14) 修理或高层次的保养工作，仅能由受过训练的机电技师来执行。
所有维修用的零件，须由本公司提供认可，方可使用。
- 15) 使用本产品请远离高频电磁波和电波发射器等，以免所产生的电磁波干扰伺服驱动装置而发生误动作。
- 16) 请不要以不适当物体来敲击或撞击本产品及各装置。

保修期限

本产品保修期限为购买日期起一年内或出厂月份起两年内。

保修内容

本产品在正常情况使用且无人为操作失误的前提下，于保修期间无偿为客户维修使能正常操作。

但以下情况于保修期间将收取维修费用：

1. 不当使用包括误接高压电源、将产品移做其它用途、自行拆卸、维修、更改、或不依规格范围使用、进水进油及插入异物于本产品。
2. 火灾、地震、闪电、风灾、水灾、盐蚀、潮湿、异常电压及其它天灾或不当场所造成的损害。
3. 客户购买后摔落本产品，或客户自行运输（或托付运输公司）造成的损害。

* 本产品在生产及测试上皆尽最大努力和严格控制使其达到高品质及高稳定的标准，但外部的电磁或静电干扰或不稳定的供应电源，仍可能对本产品造成影响或损害，因此操作场所的接地系统一定要确实做好，并建议用户安装故障安全防护装置（如漏电保护器）。

1 安装

1.1 电源线的接法

! 如使用于电源供应不稳定之国家或地区时，建议在电源供应端装置电源稳定器之设备，请务必接上大地。

1.2 马达的安装

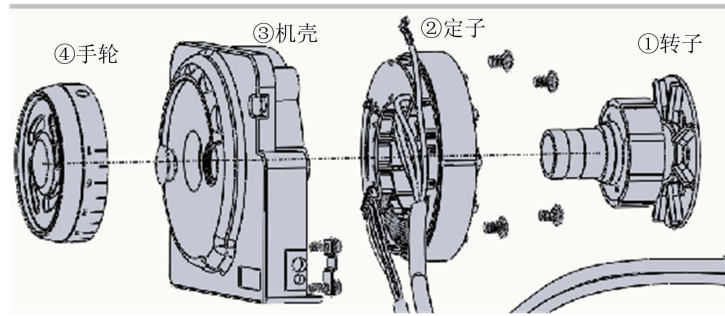

1.3 控速器踏板拉力的调整

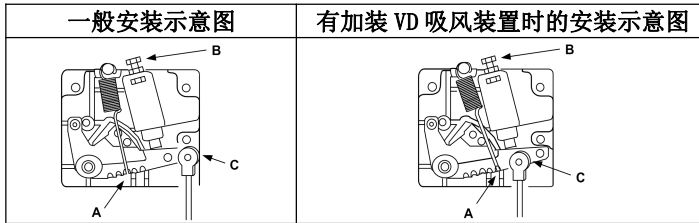

A: 前踏拉力弹簧

B: 后踏紧度制退的调整螺丝组

C: 踏板旋臂拨杆挂钩孔

∴ 踏板连接器有加装 VD 吸风系列装置时，建议将 A 与 C 改变安装如右图所示

1.4 上下停车、慢速启缝调试







在正常工作界面中、当按  键显示屏上该指示灯被点亮说明停车在上定位，该指示灯被关闭说明该此时停车位为下停针



在正常工作界面中、当按  键显示屏上该指示灯被点亮说明此时慢速起缝打开，该指示灯被关闭说明该此时慢速起缝打关闭。

2: 按键说明

参数查看保存键		对所选参数号内容进行查看和保存：选择好参数号后按此键可以进行查看和修改操作，修改参数值后按此键则退出并保存参数
进入参数区功能键		1、一般模式下按下 P 键进入用户参数设置模式 2、在关机状态，按住 P 开机进入技术员参数模式
上调节键/停针位置选择键		1、在开机界面，短按为加速键 2、在开机界面，长按 3 秒可切换上、下停针位 3、在参数界面，参数递增键
下调节键/慢速起缝选择键		1、在开机界面，短按为减速键 2、在开机界面，长按 3 秒可开启或关闭慢速起缝功能 3、在参数界面，参数递减键

3 操作说明

3.1: 恢复出厂设置



3.2 进入用户模式及修改保存

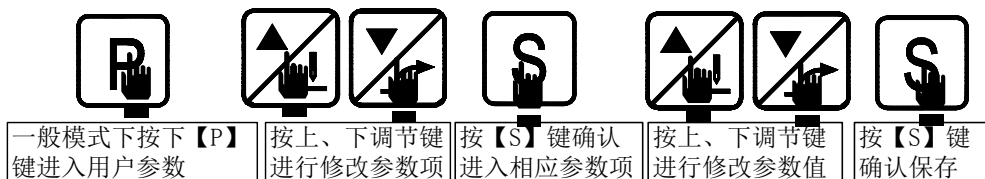

3.3.: 进入技术员模式及修改保存



4：用户参数&技术员参数

4.1 用户参数

参数项	中文说明	范围	初始值	内容值名称说明与备注
P01	最高转速	020-600	450	车缝时的最高转速设定（显示的数*10=实际速度）
P02	停针位选择	000-002	000	停针位设定（0：上停针；1：下停针；2：无定位）
P03	慢速起缝开关	000-001	000	慢速起缝开关设定（0：关 1：开）
P04	慢速起缝速度	020-150	040	慢速起缝时的速度设定（显示的数*10=实际速度）
P05	慢速起缝针数	001-015	001	慢速起缝时的针数设定，每一单位代表半针
P06	最低转速	200-500	200	车缝时的最低转速设定（显示的数*10=实际速度）

4.2 技术员参数内容表

参数项	中文说明	范围	初始值	内容值名称说明与备注
P07	上定位调整	000-024	000	
P08	下定位调整	000-024	012	
P09	开机自动找上定位	000-001	001	0：开机不找上定位；1：开机找上定位
P10	机头保护开关检测	000-002	001	0：不检测；1：检测零信号；2：检测正信号
P11	加速曲线调整（%）	001-100	032	控速器的加速爬升斜率设定
P15	补针方式	000-003	000	0：半针；1：一针；2：连续补半针；3：连续补一针；
P16	衣车灯亮度调节 （预留）	000-004	004	0：熄灭；1→4 亮度等级，数字越大亮度越大
P21	马达运转方向	000-001	000	马达运转方向设定（0：顺时针 1：逆时针）
P22	自动跑合速度	020-500	350	跑合速度的设置（显示的数*10=实际速度）
P23	自动跑合跑时间	010-250	020	测试中，设置跑时间
P24	自动跑合停时间	010-250	020	测试中，设置停时间
P25	A 项测试	000-001	000	A 项测试设定（速度持续运行）
P26	B 项测试	000-001	000	B 项测试设定（执行定位循环运行）
P29	吸气功能选择	000-002	001	0：关闭；1：吸气功能；2：半反踏气动抬压脚功能
P36	机型	000-010	008	

5：错误代码表：

错误码	内容	对策
E01	1) 电源 ON 时，主电压检测过高 2) 供应电源电压过高时	关闭系统电源，检测供应电源电压是否正确。（或是否超过使用规定的额定电压）。 若正确，请更换控制箱并通知厂方。
E07	a) 马达插头配线接触不良导致不转。 b) 车头机构死锁或马达皮带异物卷入卡死。 c) 加工物过厚，马达扭力不足无法贯穿。 d) 模块驱动出力异常。	转动机头电机手轮观察是否卡住。如卡住则先排除机头机械故障。 如转动正常，检查电机编码器接头和电机电源线接头是否松动。如有松动请修正。 如接触良好，检查供应电源电压是否异常或转速设置过高。如有请调整。 如正常，请更换控制箱并通知厂方。
E09 E11	定位信号异常	关闭系统电源，检查电机编码器接口是否松动或脱落，将其恢复正常后重启系统。若仍不能正常工作，请更换电机并通知厂方。
E12	电源开启时，忘记插入定位器。	自动进入无定位器模式运作，且切线、扫线、上定位等以及所有定针缝式样缝制功能亦无效。马达可正常操作。（请检查定位器是否忘记插入或异常）



E14	编码器信号异常	关闭系统电源，检查电机编码器接口是否松动或脱落，将其恢复正常后重启系统。若仍不能正常工作，请更换电机并通知厂方。
E15	电力模块不正常过流保护	关闭系统电源，再重新开启。若仍不能正常工作，请更换控制箱并通知厂方。
E17	机头保护开关没到正确位置	关闭系统电源，检查机头是否掀开，控制箱内滚珠开关是否移位或损坏。

6: 端口示意图

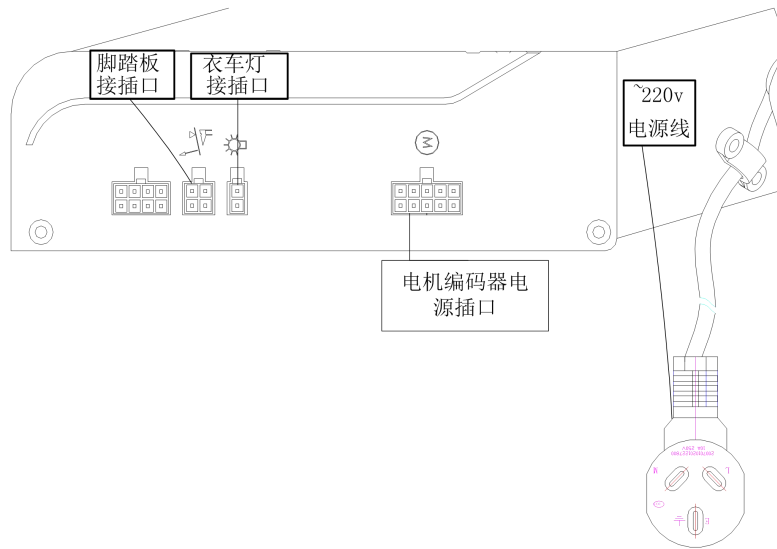
6.1.1: 各个端口说明:



Safety Instruction

1. Users are required to read the operation manual completely and carefully before installation or operation.
2. All the instruction marked with sign  must be observed or executed; otherwise, bodily injuries might occur.
3. The product should be installed and pre-operated by well trained persons.
4. For perfect operation and safety, it is prohibited that using extension cable with multi-outlet for power connection.
5. When connecting power supply cords to power sources, it is necessary to make sure that the power voltage is lower than 250 VAC and matches the rated voltage indicated on the motor's name plate.
 ※Attention: If the Control Box is AC 220V system, please don't connect the Control Box to AC 380V power outlet. Otherwise, the error will occur and motor will not work. If that happens, please turn off the power immediately and check the power voltage.
6. Don't operate in direct sun light, outdoors area and where the room temperature is over 45°C or below 5°C.
7. Please avoid operating near the heater at dew area or at the humidity below 30% or above 95%.
8. Don't operate in area with heavy dust, corrosive substance or volatile gas.
9. Avoid power cord being applied by heavy objects or excessive force, or over bend.
10. The earth wire of power cord must be connected to the system ground of the production plant by proper size of conductions and terminals. This connection should be fixed permanently.
11. All the moving portions must be prevented to be exposed by the parts provided.
12. Turing on the machine in the first time, operate the sewing machine at low speed and check the correct rotation direction.
13. Turn off the power before the following operation:
 - a) Connecting or disconnecting any connectors on the control box or motor.
 - b) Threading needle.
 - c) Raising the machine head.
 - d) Repairing or doing any mechanical adjustment.
 - e) Machines idling.
14. Repairs and high level maintenance work should only be carried out by electronic technicians with appropriate training.
15. All the spare parts for repair must be provided or approved by the manufacturer.
16. Don't use any objects or force to hit or ram the product.

Guarantee Time

Warranty period of this product is 1 year dated from purchasing, or within 2 years from ex-factory date.

Warranty Detail:

Any trouble found within warranty period under normal operation, it will be repaired free of charge. However, maintenance cost will be charged in the following cases even if within warranty period:

1. Inappropriate use, including: wrong connecting high voltage, wrong application, disassemble, repair, modification by incompetent personnel, or operation without the precaution, or operation out of its specification range, or inserting other objects or liquids into the product.
2. Damage by fire, Earth quake, lighting, wind, flood, salt corrosive, moisture, abnormal power voltage and any other damage cause by the natural disaster or by the inappropriate environments.
3. Dropping after purchasing or damage in transportation by customer himself or by customer's shipping agency

Note: We make our best effort to test and manufacture the product for assuring the quality. However, it is possible that this product can be damaged due to external magnetic interference and electronic static or noise or unstable power source more than expected; therefore the grounding system of operate area must guarantee the good earth and it's also commended to install a failsafe device. (Such as residual current breaker)

1 Installation

1.1 Power Connection

! For countries or regions with unstable power supply, it is proposed to install a power stabilizer.

1.2 Motor Installation:

Installation of Internal Motor

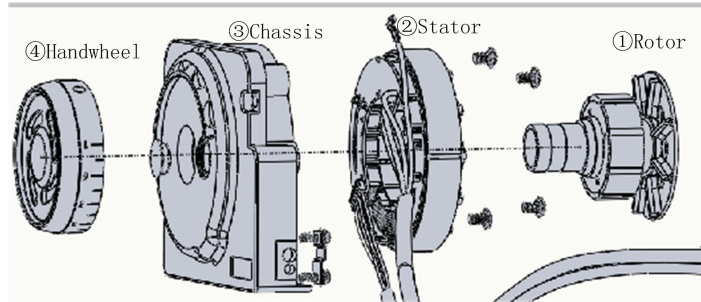

1.3 Adjust The Force Required To Operate The Foot Pedal

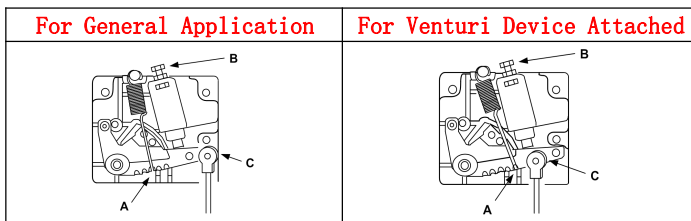

Spring A: Downward force adjustment
 Bolt B: Heeling back force adjustment
 Hole C: Pedal stroke adjustment

∴ In case of connecting with an air switch on the pedal rod to activate a Venturi Device, please shift the position for A and C as shown below.

1.4 Upper and lower stop debugging, Slow start joint debugging

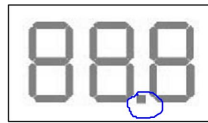

In normal operating interface, when the button on the screen the indicating lamp was lit in the parking position, the indicator light is off the time parking for lower needle stop



In normal operating interface, when the button on the screen the indication lamp is lit up the slow play slot open, the indicating lamp is off the slow play off the seam.

2: Keysfunction

Setting Parameter Check And Save		After setting the function code, press this key to check the preset parameter and then can edit the parameter accordingly; When the parameter is fixed, press key to save the setting and quit.
Entering the parameter mode		1. Press key P to enter into user parameter setting mode. 2. Long press key P, in the same time turn on the power switch from off to enter into system parameter setting mode.
On the adjustment key/ Select the shortcut needle position		1. Choose the region parameter items incrementing key 2. Parameter setting value incrementing key 3. Select the shortcut needle position
Under the adjustment key/ Slow play seam selection shortcuts		1. Choose the region parameter items of diminishing key 2. Is decremented key parameter settings 3. Slow play seam selection shortcuts

3 Operating instructions

3.1: Reset the system



Press and hold the upper and lower adjustment key while turning the power

Press [S] to confirm; shutdown restart

3.2 Enter the user argument and save changes



Under normal mode
Press [P] to enter
user parameters



Press the upper and
lower adjustment key;
modify parameter items



Press [S]
key to enter



Press the upper and
lower adjustment key;
modify parameter values



Press [S] key to
confirm the save

3.3 Enter technician mode and save changes

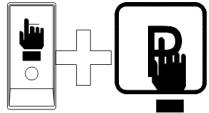

Press and hold the [P]
key to boot into the
technician parameters

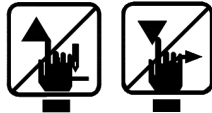

Press the Up and Down
keys to adjust; Modify
parameter items



Press [S] key
to enter



Press the Up and Down
keys to adjust; modify
parameter values



Press [S] key
to confirm the
save

4: User Parameter & Technician Parameter

4.1 User Parameter

Parameters	Parameter Function	Range	Default	Description
P01	Maximum speed	020-600	450	set the max sewing speed (show the actual number *10= speed)
P02	needle stop position selection	000-002	000	Set the needle stop position(0: needle up 1:needle down)
P03	soft start switch	000-001	000	soft start switch setting(0:OFF 1: ON)
P04	soft start sewing speed	020-150	040	soft start sewing speed setting(show the actual number *10= speed)
P05	stitches number of soft start	001-015	001	set the stitches number of soft start, each unit is half stitch
P06	Minimum speed	200-500	200	set the minimum speed (show the actual number *10= speed)

4.2 Technician Parameter

Parameters	Parameter Function	Range	Default	Description
P07	Up Position Adjustment	000-024	000	
P08	Down Position Adjustment	000-024	012	
P09	Needles Goes Up Automatically as Power turned on	000-001	001	0: No Function. 1: Power turned on, needle goes up position automatically
P11	Speed Curve Adjustment (%)	001-100	032	The Lager the value, the faster to increase speed
P15	Stitch Correction Mode	000-003	000	0: Half stitch 1: One stitch 2. Continuous correct half stitch Continuous correct stitch and quickly stop machine.
P21	motor rotate direction	000-001	000	motor rotate direction setting (0:clockwise 1:counter-clockwise)
P22	auto running speed	020-500	350	auto running speed setting(show the actual number *10= speed)
P23	auto running time	010-250	020	set the auto running time in testing
P24	auto running stop time	010-250	020	set the auto running stop time in testing
P25	Item A test	000-001	000	Item A test setting(continue running with constant speed)
P26	Item B test	000-001	000	Item B test setting(carry out the set loop running)
P29	Inhale feature selection	000-002	001	0: OFF; 1: Inhale feature; 2: Foot Lifting when Half-Heeling the Pedal
P36	Type	000-010	008	

5 Error Code Table:

Error	Problem	Measurement
-------	---------	-------------

E01	1) When power on, detected main voltage too high. 2) When the supply voltage is too high	Turn off the system power supply, and detect whether the supply voltage is correct. (Or exceed the rated voltage.) If correct, please replace the control box and inform the factory
E07	a)Bad connection at the motor connector. b)Machine locked or object stuck in the motor pulley c)Sewing material is too thick. d)Module output is abnormal.	Please check the machine head to see if objects stuck in the motor pulley. If stuck it is not the machine head machinery fault. If normal running, please check the encoder connector and motor power cord connector if loose. If loose please tight connection. If connection well, please check supply voltage whether abnormal or setting speed too high. If have please modify. If normal, please replace the control box and notify the manufacturer.
E09 E11	Synchronizer signal error.	Turn off the system power supply, please check motor encoder connector if loose or fall off, renew to normal then restart system. If still not work, please replace the motor and notify the manufacture.
E12	Power is turned on without the synchronizer signal.	Motor still can run, but it automatically starts the clutch mode. All constant-stitch sewing pattern and trimmer /wiper function is invalid. Please check the synchronizer.
E14	Encoder signal error.	Turn off the system power supply, please check motor encoder connector if loose or fall off, renew to normal then restart system. If still not work, please replace the motor and notify the manufacture.
E15	Power module abnormal over current protection	Module driver output and head output will close all. Waiting for the power to open / reset. (please carefully check power supply board each function)
E17	The sewing table safety switch is not in the correct position	Please check sewing table is open or not, the sewing table safety switch is damage or not, the socket is abnormal or not.

6: Schematic diagram of port

6.1.1: Each port name:

